

Royopto 荣一·光科技

Product Specification

IR5086-S18

Royopto

5mm Infrared LED
IR5086-S18

IR5086-S18



Features

- High reliability
- High radiant intensity
- Peak wavelength $\lambda_p=940\text{nm}$
- 2.54mm Lead spacing
- Low forward voltage
- Pb free
- This product itself will remain within RoHS compliant version.
- Compliance with EU REACH
- Compliance Halogen Free(Br < 900ppm, Cl < 900ppm, Br+Cl < 1500ppm)

Descriptions

- Royopto's Infrared Emitting Diode is a high intensity diode , molded in a blue transparent plastic package.
- The device is spectrally matched with phototransistor , photodiode and infrared receiver module.

Applications

- Free air transmission system
- Infrared remote control units with high power requirement
- Smoke detector
- Infrared applied system

Device Selection Guide

Device No.	Chip Materials	Lens Color
IR5086-S18	GaAlAs	Blue

5mm Infrared LED IR5086-S18

Package Dimension

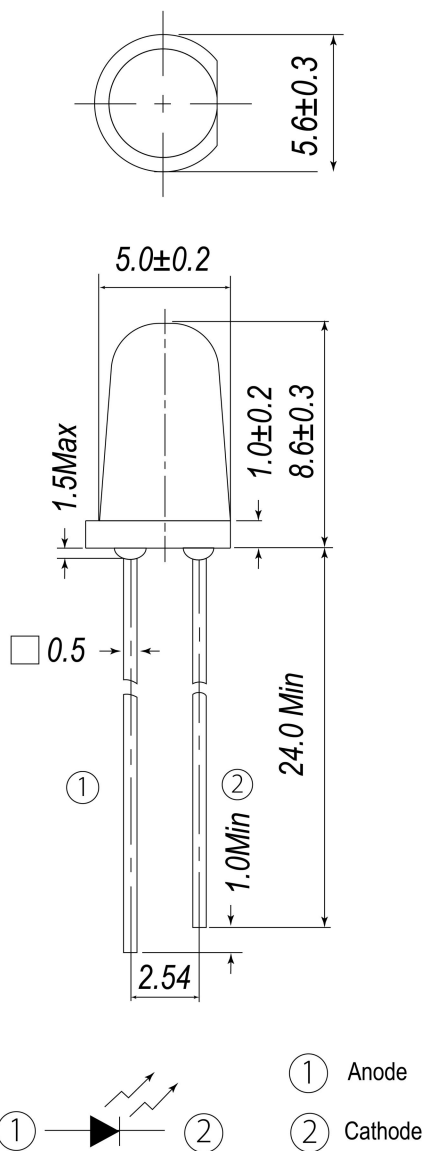

Note:

- 1.All dimensions are in millimeters
- 2.Tolerances unless dimensions $\pm 0.25\text{mm}$

**5mm Infrared LED
IR5086-S18**
Absolute Maximum Ratings(Ta=25°C)

Parameter	Symbol	Ratings	Unit
Continuous Forward Current	I_F	100	mA
Peak Forward Current(*1)	I_{FP}	1.0	A
Reverse Voltage	V_R	5	V
Operating Temperature	T_{opr}	-40 ~ +85	°C
Storage Temperature	T_{stg}	-40 ~ +100	°C
Soldering Temperature(*2)	T_{sol}	260	°C
Power Dissipation at (or below) 25°C Free Air Temperature	P_d	150	mW

Notes:

1. I_{FP} Conditions--Pulse Width $\leq 100\mu s$ and Duty $\leq 1\%$.
2. Soldering time ≤ 5 seconds.

Electro-Optical Characteristics(Ta=25°C)

Parameter	Symbol	Condition	Min.	Typ.	Max.	Units
Radiant Intensity	I_e	$I_F=20mA$	21	34	--	mW/sr
		$I_F=100mA$ Pulse Width $\leq 100\mu s$,Duty $\leq 1\%$	--	80	--	
		$I_F=1A$ Pulse Width $\leq 100\mu s$,Duty $\leq 1\%$	--	760	--	
Peak Wavelength	λ_p	$I_F=20mA$	--	940	--	nm
Spectral Bandwidth	$\Delta\lambda$	$I_F=20mA$	--	45	--	nm
Forward Voltage	V_F	$I_F=20mA$	--	1.2	1.5	V
		$I_F=100mA$ Pulse Width $\leq 100\mu s$,Duty $\leq 1\%$	--	1.4	1.8	
		$I_F=1A$ Pulse Width $\leq 100\mu s$,Duty $\leq 1\%$	--	2.6	4.0	
Reverse Current	I_R	$V_R=5V$	--	--	10	μA
View Angle	2 θ 1/2	$I_F=20mA$	--	18	--	deg

5mm Infrared LED IR5086-S18

Rank

Parameter	Condition	Min.	Max.	Unit
Q	I _F =20mA	21.0	34.0	mW/sr
R	I _F =20mA	30.0	48.0	mW/sr
S	I _F =20mA	42.0	67.0	mW/sr

Reliability Test Item And Condition

- The reliability of products shall be satisfied with items listed below.
- Confidence level: 90% LTPD: 10%

NO.	Item	Test Conditions	Test Conditions	Sample Sizes	Failure Judgement Criteria	Ac/Re
1	Solder Heat	TEMP.: 260°C±5°C	10secs	22pcs	Attenuation of Power brightness or Electrical value>20%	0/1
2	Temperature Cycle	H : +100°C 30mins ↕ 5mins L : -40°C 30mins	300Cycles	22pcs		0/1
3	Thermal Shock	H :+100°C 5mins ↕ 10secs L :-10°C 5mins	300Cycles	22pcs		0/1
4	High Temperature Storage	TEMP: +100°C	1000hrs	22pcs		0/1
5	Low Temperature Storage	TEMP: -40°C	1000hrs	22pcs		0/1
6	DC Operating Life	I _F =20mA	1000hrs	22pcs		0/1
7	High Temperature/ High Humidity	85°C / 85% R.H	1000hrs	22pcs		0/1

Typical Electrical/Optical/Characteristics Curves

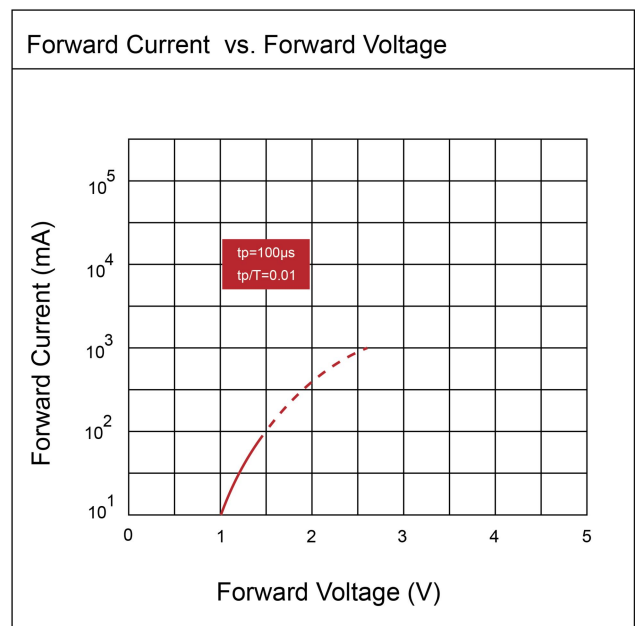
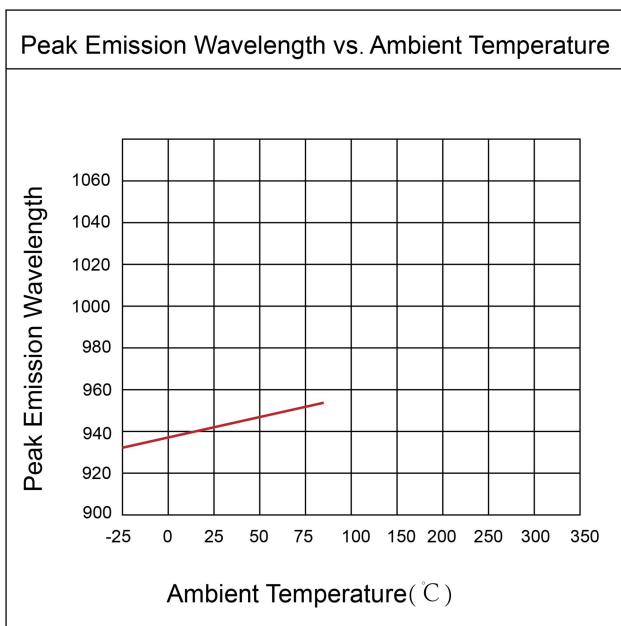
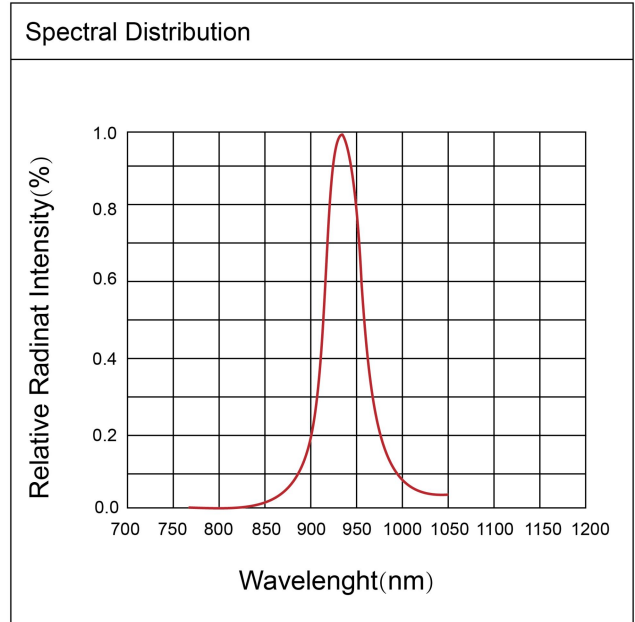
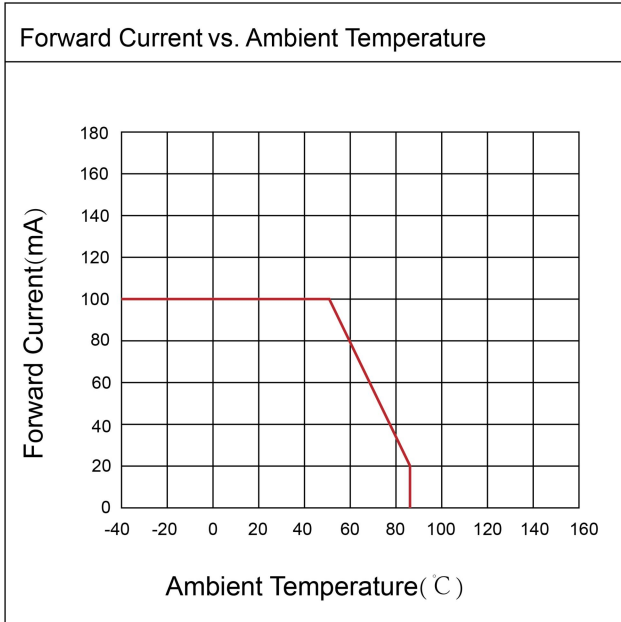

5mm Infrared LED IR5086-S18

Radiant Intensity vs. Forward Current

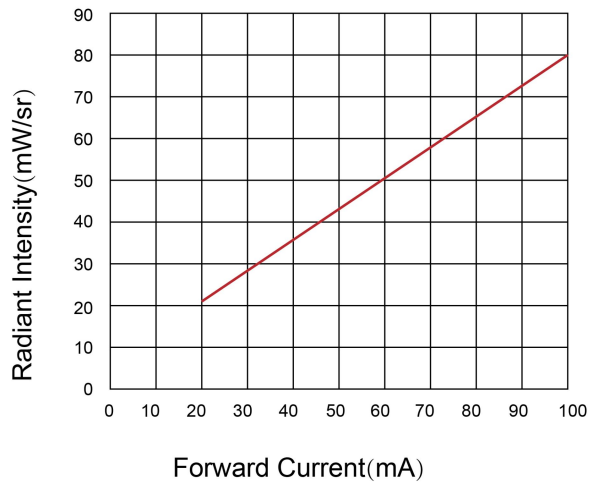

Relative Radiant Intensity vs. Angular Displacement

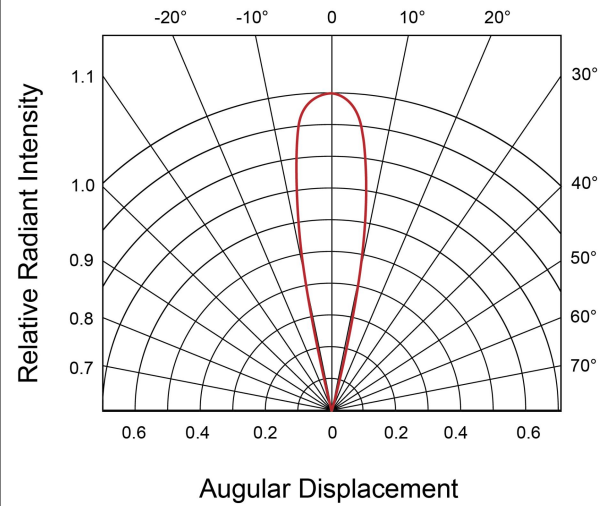

Relative Intensity vs. Ambient Temperature (°C)

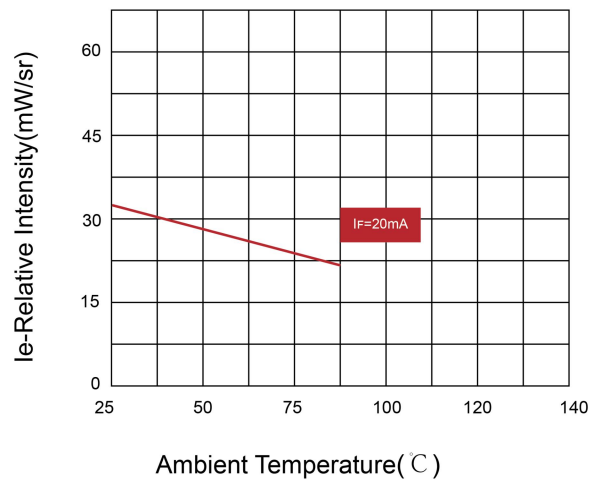

Forward Current vs. Ambient Temperature (°C)

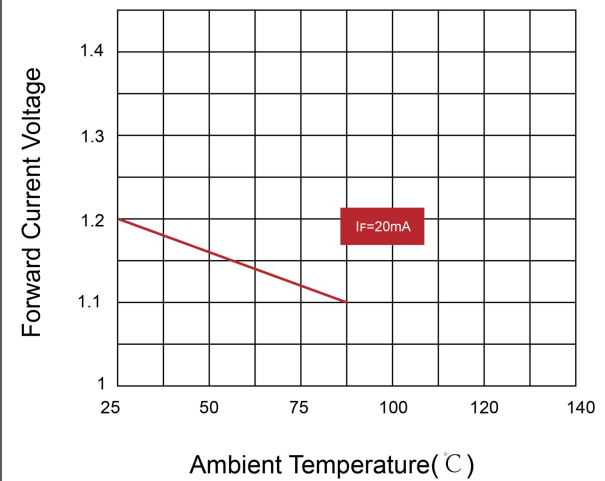

5mm Infrared LED IR5086-S18

Package Dimensions

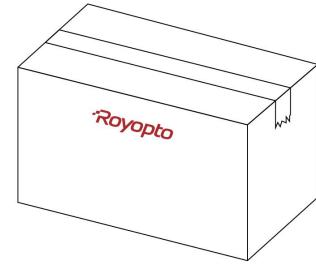

Anti-electrostatic bag

Inner Bag

Outside Carton

Size: 210*160mm

215*145*96mm

535*318*240mm

Packing: 500pcs/Bag

5Bags/Box

10Boxes/Carton

Label Form Specification

- CPN: Customer's Product Number
- MAT: Product Number
- QTY: Packing Quantity
- CAT: Luminous Intensity Rank
- HUE: Dom. Wavelength Rank
- REF: Forward Voltage Rank
- LOTNO: Lot Number
- DC: Date Created
- SERNO: Identify Label Number



5mm Infrared LED IR5086-S18

Notes

1. Lead Forming

- During lead formation, the leads should be bent at a point at least 3mm from the base of the epoxy bulb.
- Lead forming should be done before soldering.
- Avoid stressing the LED package during leads forming. The stress to the base may damage the LED's characteristics or it may break the LEDs.
- Cut the LED lead frames at room temperature. Cutting the lead frames at high temperatures may cause failure of the LEDs.
- When mounting the LEDs onto a PCB, the PCB holes must be aligned exactly with the lead position of the LED. If the LEDs are mounted with stress at the leads, it causes deterioration of the epoxy resin and this will degrade the LEDs.

2. Storage

- The LEDs should be stored at 30°C or less and 70%RH or less after being shipped from Royopto and the storage life limits are 3 months. If the LEDs are stored for 3 months or more, they can be stored for a year in a sealed container with a nitrogen atmosphere and moisture absorbent material.
- Please avoid rapid transitions in ambient temperature, especially, in high humidity environments where condensation can occur.

3. Soldering

- Careful attention should be paid during soldering. When soldering, leave more than 3mm from solder joint to epoxy bulb, and soldering beyond the base of the tie bar is recommended.
- Recommended soldering conditions:

Hand Soldering		DIP Soldering	
Temp. at tip of iron	300°C Max. (30W Max.)	Preheat temp.	100°C Max. (60 sec Max.)
Soldering time	3 sec Max.	Bath temp. & time	260 Max., 5 sec Max
Distance	3mm Min.(From solder joint to epoxy bulb)	Distance	3mm Min. (From solder joint to epoxy bulb)

5mm Infrared LED IR5086-S18

■ Recommended soldering profile



- Avoiding applying any stress to the lead frame while the LEDs are at high temperature particularly when soldering.
- Dip and hand soldering should not be done more than one time.
- After soldering the LEDs, the epoxy bulb should be protected from mechanical shock or vibration until the LEDs return to room temperature.
- A rapid-rate process is not recommended for cooling the LEDs down from the peak temperature. Although the recommended soldering conditions are specified in the above table, dip or hand soldering at the lowest possible temperature is desirable for the LEDs.
- Wave soldering parameter must be set and maintain according to recommended temperature and dwell time in the solder wave.

4. Cleaning

- When necessary, cleaning should occur only with isopropyl alcohol at room temperature for a duration of no more than one minute. Dry at room temperature before use.
- Do not clean the LEDs by the ultrasonic. When it is absolutely necessary, the influence of ultrasonic cleaning on the LEDs depends on factors such as ultrasonic power and the assembled condition. Ultrasonic cleaning shall be pre-qualified to ensure this will not cause damage to the LED.

5. Heat Management

**5mm Infrared LED
IR5086-S18**

- Heat management of LEDs must be taken into consideration during the design stage of LED application. The current should be de-rated appropriately by referring to the de-rating curve found in each product specification.
- The temperature surrounding the LED in the application should be controlled. Please refer to the data sheet de-rating curve.

6. ESD (Electrostatic Discharge)

- Electrostatic discharge (ESD) or surge current (EOS) can damage LEDs.
- An ESD wrist strap, ESD shoe strap or antistatic gloves must be worn whenever handling LEDs.
- All devices, equipment and machinery must be properly grounded.
- Use ion blower to neutralize the static charge which might have built up on surface of the LEDs plastic lens as a result of friction between LEDs during storage and handing.

7. Other

- Above specification may be changed without notice. Royopto will reserve authority on material change for above specification.
- When using this product, please observe the absolute maximum ratings and the instructions for using outlined in these specification sheets. Royopto assumes no responsibility for any damage resulting from use of the product which does not comply with the absolute maximum ratings and the instructions included in these specification sheets.
- These specification sheets include materials protected under copyright of Royopto corporation. Please don't reproduce or cause anyone to reproduce them without Royopto's consent.