

**Royopto** 荣一·光科技

# Product Specification

IR383-41

**Royopto**

### 5mm Infrared LED IR383-41

## IR383-41



### Features

- High reliability
- High radiant intensity
- Peak wavelength  $\lambda_p=940\text{nm}$
- 2.54mm Lead spacing
- Low forward voltage
- Pb free
- This product itself will remain within RoHS compliant version.
- Compliance with EU REACH
- Compliance Halogen Free(Br < 900ppm, Cl < 900ppm, Br+Cl < 1500ppm)

### Descriptions

- Royopto's Infrared Emitting Diode is a high intensity diode , molded in a blue transparent plastic package.
- The device is spectrally matched with phototransistor , photodiode and infrared receiver module.

### Applications

- Free air transmission system
- Infrared remote control units with high power requirement
- Smoke detector
- Infrared applied system

### Device Selection Guide

| Device No. | Chip Materials | Lens Color |
|------------|----------------|------------|
| IR383-41   | GaAlAs         | Blue       |

### 5mm Infrared LED IR383-41

#### Package Dimension

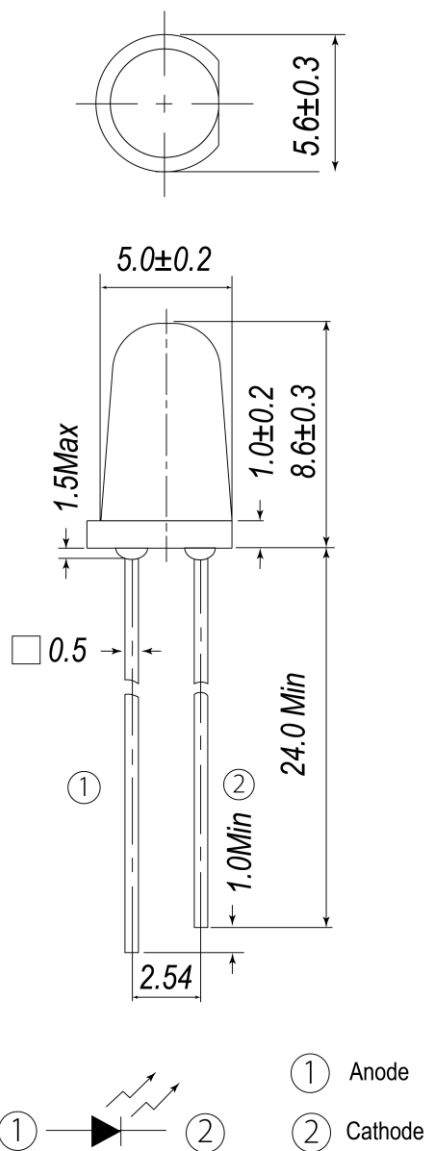

#### Note:

1. All dimensions are in millimeters
2. Tolerances unless dimensions  $\pm 0.25$  mm

**5mm Infrared LED  
IR383-41**
**Absolute Maximum Ratings(Ta=25°C)**

| Parameter   | Symbol    | Ratings    | Unit |
|---|-----------|------------|------|
| Continuous Forward Current                                | $I_F$     | 100        | mA   |
| Peak Forward Current(*1)                                  | $I_{FP}$  | 1.0        | A    |
| Reverse Voltage   | $V_R$     | 5          | V    |
| Operating Temperature                                     | $T_{opr}$ | -40 ~ +85  | °C   |
| Storage Temperature                                       | $T_{stg}$ | -40 ~ +100 | °C   |
| Soldering Temperature(*2)                                 | $T_{sol}$ | 260        | °C   |
| Power Dissipation at (or below) 25°C Free Air Temperature | $P_d$     | 150        | mW   |

Notes:

1.  $I_{FP}$  Conditions--Pulse Width $\leq$ 100 $\mu$ s and Duty $\leq$ 1%.
2. Soldering time $\leq$ 5 seconds.

**Electro-Optical Characteristics(Ta=25°C)**

| Parameter          | Symbol          | Condition  | Min. | Typ. | Max. | Units   |
|--------------------|-----------------|--|------|------|------|---------|
| Radiant Intensity  | $I_e$           | $I_F=20\text{mA}$  | 21   | 34   | --   | mW/sr   |
|                    |                 | $I_F=100\text{mA}$<br>Pulse Width $\leq$ 100 $\mu$ s ,Duty $\leq$ 1% | --   | 80   | --   |         |
|                    |                 | $I_F=1\text{A}$<br>Pulse Width $\leq$ 100 $\mu$ s ,Duty $\leq$ 1%    | --   | 760  | --   |         |
| Peak Wavelength    | $\lambda_p$     | $I_F=20\text{mA}$  | --   | 940  | --   | nm      |
| Spectral Bandwidth | $\Delta\lambda$ | $I_F=20\text{mA}$  | --   | 45   | --   | nm      |
| Forward Voltage    | $V_F$           | $I_F=20\text{mA}$  | --   | 1.2  | 1.5  | V       |
|                    |                 | $I_F=100\text{mA}$<br>Pulse Width $\leq$ 100 $\mu$ s ,Duty $\leq$ 1% | --   | 1.4  | 1.8  |         |
|                    |                 | $I_F=1\text{A}$<br>Pulse Width $\leq$ 100 $\mu$ s ,Duty $\leq$ 1%    | --   | 2.6  | 4.0  |         |
| Reverse Current    | $I_R$           | $V_R=5\text{V}$  | --   | --   | 10   | $\mu$ A |
| View Angle         | 2 $\theta$ 1/2  | $I_F=20\text{mA}$  | --   | 18   | --   | deg     |

**Rank**

| Parameter | Condition            | Min. | Max. | Unit  |
|-----------|----------------------|------|------|-------|
| Q         | I <sub>F</sub> =20mA | 21.0 | 34.0 | mW/sr |
| R         | I <sub>F</sub> =20mA | 30.0 | 48.0 | mW/sr |
| S         | I <sub>F</sub> =20mA | 42.0 | 67.0 | mW/sr |

**Reliability Test Item And Condition**

■ The reliability of products shall be satisfied with items listed below.

■ Confidence level: 90% LTPD: 10%

| NO. | Item                            | Test Conditions                                  | Test Conditions | Sample Sizes | Failure Judgement Criteria                              | Ac/Re |
|-----|---------------------------------|--|-----------------|--------------|---|-------|
| 1   | Solder Heat                     | TEMP.: 260°C±5°C                                 | 10secs          | 22pcs        | Attenuation of Power brightness or Electrical value>20% | 0/1   |
| 2   | Temperature Cycle               | H : +100°C 30mins<br>↕ 5mins<br>L : -40°C 30mins | 300Cycles       | 22pcs        |   | 0/1   |
| 3   | Thermal Shock                   | H : +100°C 5mins<br>↕ 10secs<br>L : -10°C 5mins  | 300Cycles       | 22pcs        |   | 0/1   |
| 4   | High Temperature Storage        | TEMP: +100°C                                     | 1000hrs         | 22pcs        |   | 0/1   |
| 5   | Low Temperature Storage         | TEMP: -40°C                                      | 1000hrs         | 22pcs        |   | 0/1   |
| 6   | DC Operating Life               | I <sub>F</sub> =20mA                             | 1000hrs         | 22pcs        |   | 0/1   |
| 7   | High Temperature/ High Humidity | 85°C/ 85% R.H                                    | 1000hrs         | 22pcs        |   | 0/1   |

#### Typical Electrical/Optical/Characteristics Curves

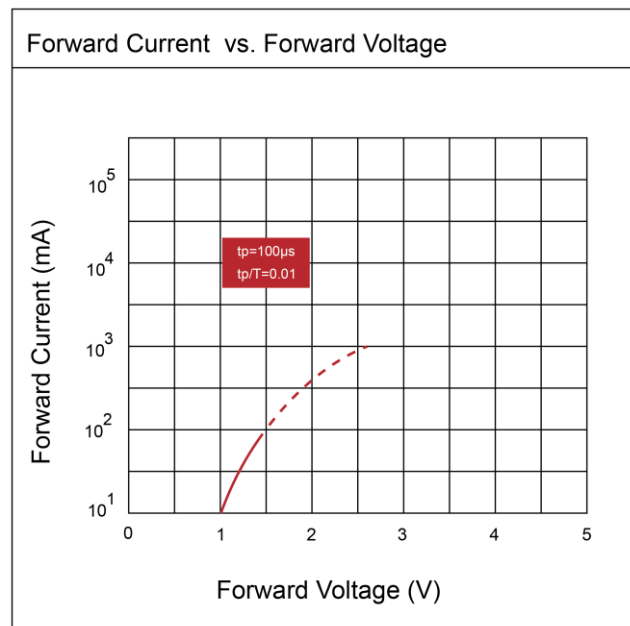
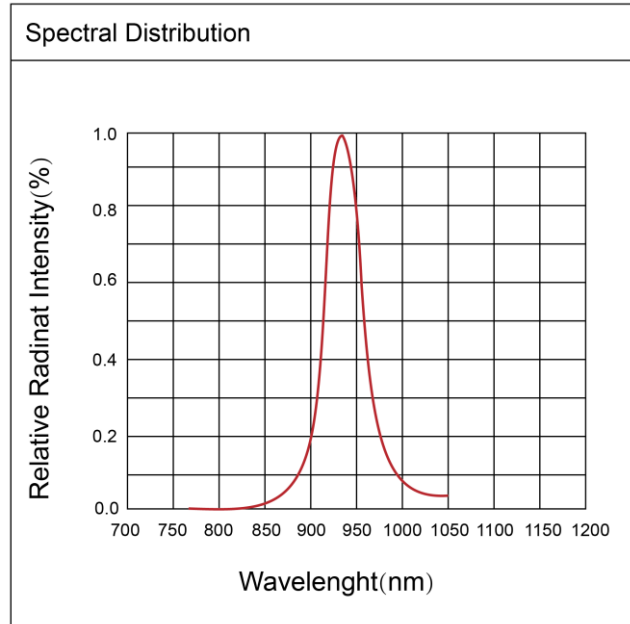

### 5mm Infrared LED IR383-41

Radiant Intensity vs. Forward Current

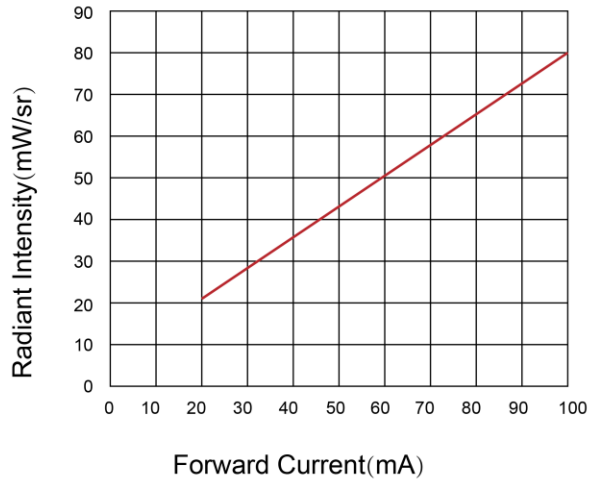

Relative Radiant Intensity vs. Angular Displacement

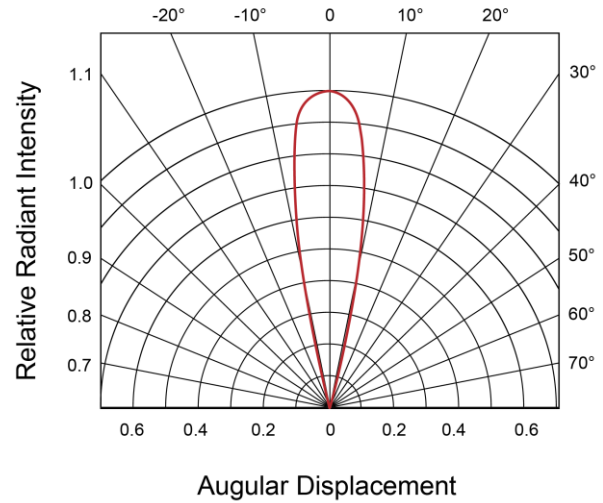

Relative Intensity vs. Ambient Temperature (°C)

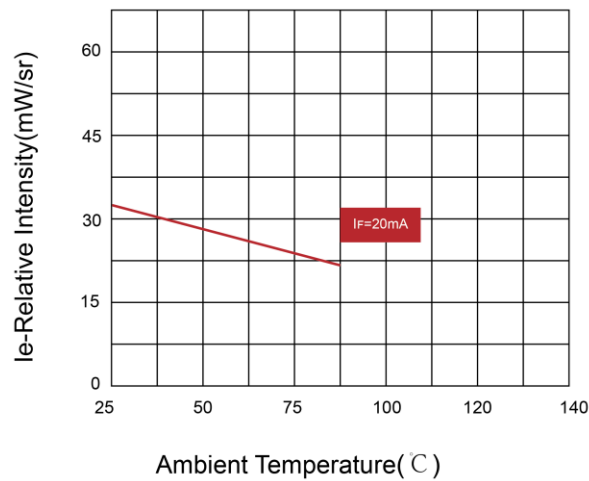

Forward Voltage vs. Ambient Temperature (°C)

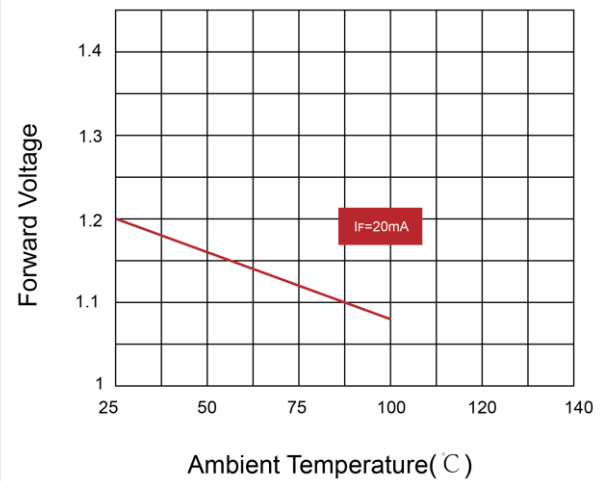

### 5mm Infrared LED IR383-41

#### Package Dimensions

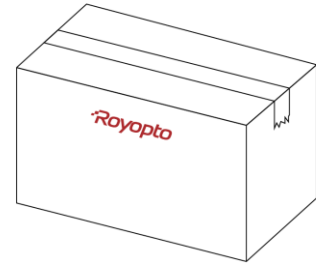
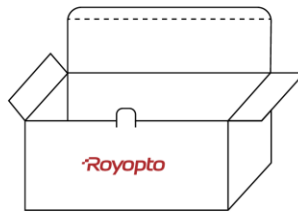

Anti-electrostatic bag

Inner Bag

Outside Carton

Size: 210\*160mm

215\*145\*96mm

535\*318\*240mm

Packing: 500pcs/Bag

5Bag/Box

10Boxes/Carton

#### Label Form Specification

- CPN: Customer's Product Number
- MAT: Product Number
- QTY: Packing Quantity
- CAT: Luminous Intensity Rank
- HUE: Dom. Wavelength Rank
- REF: Forward Voltage Rank
- LOTNO: Lot Number
- DC: Date Created
- SERNO: Identify Label Number



#### Notes

##### 1. Lead Forming

- During lead formation, the leads should be bent at a point at least 3mm from the base of the epoxy bulb.
- Lead forming should be done before soldering.
- Avoid stressing the LED package during leads forming. The stress to the base may damage the LED's characteristics or it may break the LEDs.
- Cut the LED lead frames at room temperature. Cutting the lead frames at high temperatures may cause failure of the LEDs.
- When mounting the LEDs onto a PCB, the PCB holes must be aligned exactly with the lead position of the LED. If the LEDs are mounted with stress at the leads, it causes deterioration of the epoxy resin and this will degrade the LEDs.

##### 2. Storage

- The LEDs should be stored at 30°C or less and 70%RH or less after being shipped from Royopto and the storage life limits are 3 months. If the LEDs are stored for 3 months or more, they can be stored for a year in a sealed container with a nitrogen atmosphere and moisture absorbent material.
- Please avoid rapid transitions in ambient temperature, especially, in high humidity environments where condensation can occur.

##### 3. Soldering

- Careful attention should be paid during soldering. When soldering, leave more than 3mm from solder joint to epoxy bulb, and soldering beyond the base of the tie bar is recommended.
- Recommended soldering conditions:

| Hand Soldering       |   | DIP Soldering     |  |
|----------------------|---|-------------------|--|
| Temp. at tip of iron | 300°C Max. (30W Max.)                     | Preheat temp.     | 100°C Max. (60 sec Max.)                   |
| Soldering time       | 3 sec Max.                                | Bath temp. & time | 260 Max., 5 sec Max                        |
| Distance             | 3mm Min.(From solder joint to epoxy bulb) | Distance          | 3mm Min. (From solder joint to epoxy bulb) |

### 5mm Infrared LED IR383-41

#### ■ Recommended soldering profile

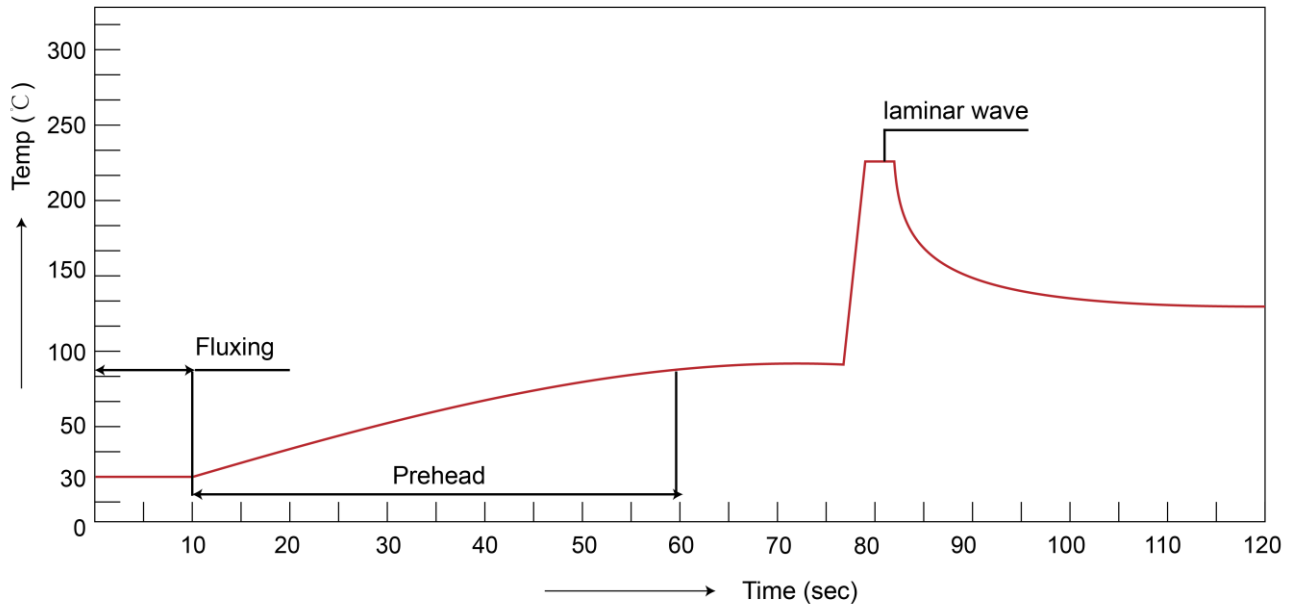

- Avoiding applying any stress to the lead frame while the LEDs are at high temperature particularly when soldering.
- Dip and hand soldering should not be done more than one time.
- After soldering the LEDs, the epoxy bulb should be protected from mechanical shock or vibration until the LEDs return to room temperature.
- A rapid-rate process is not recommended for cooling the LEDs down from the peak temperature. Although the recommended soldering conditions are specified in the above table, dip or hand soldering at the lowest possible temperature is desirable for the LEDs.
- Wave soldering parameter must be set and maintain according to recommended temperature and dwell time in the solder wave.

#### 4. Cleaning

- When necessary, cleaning should occur only with isopropyl alcohol at room temperature for a duration of no more than one minute. Dry at room temperature before use.
- Do not clean the LEDs by the ultrasonic. When it is absolutely necessary, the influence of ultrasonic cleaning on the LEDs depends on factors such as ultrasonic power and the assembled condition. Ultrasonic cleaning shall be pre-qualified to ensure this will not cause damage to the LED.

#### 5. Heat Management

**5mm Infrared LED  
IR383-41**

- Heat management of LEDs must be taken into consideration during the design stage of LED application. The current should be de-rated appropriately by referring to the de-rating curve found in each product specification.
- The temperature surrounding the LED in the application should be controlled. Please refer to the data sheet de-rating curve.

**6. ESD (Electrostatic Discharge)**

- Electrostatic discharge (ESD) or surge current (EOS) can damage LEDs.
- An ESD wrist strap, ESD shoe strap or antistatic gloves must be worn whenever handling LEDs.
- All devices, equipment and machinery must be properly grounded.
- Use ion blower to neutralize the static charge which might have built up on surface of the LEDs plastic lens as a result of friction between LEDs during storage and handing.

**7. Other**

- Above specification may be changed without notice. Royopto will reserve authority on material change for above specification.
- When using this product, please observe the absolute maximum ratings and the instructions for using outlined in these specification sheets. Royopto assumes no responsibility for any damage resulting from use of the product which does not comply with the absolute maximum ratings and the instructions included in these specification sheets.
- These specification sheets include materials protected under copyright of Royopto corporation. Please don't reproduce or cause anyone to reproduce them without Royopto's consent.